

B & K Components, Ltd.

User Manual

REFERENCE 125.2 S2

Two Channel Amplifier

USER MANUAL - REFERENCE 125.2

© 2004 B&K Components Ltd. All rights reserved.

The information in this manual is copyright protected. No part of this manual may be copied or reproduced in any form without prior written consent from B & K Components, Ltd.

B&K Components Ltd. SHALL NOT BE LIABLE FOR OPERATIONAL, TECHNICAL OR EDITORIAL ERRORS/OMISSIONS MADE IN THIS MANUAL. The information in this manual may be subject to change without prior notice.

Accessories Included

- 1 - Reference 125.2 S2
- 1 - User Manual
- 1 - Power Cord
- 1 - Warranty Card



SIMPLY BETTER!

SIMPLY BETTER! is a registered trademark of B&K Components, Ltd. All other brand or product names are trademarks or registered trademarks of their respective companies or organizations.

Limited Warranty

B&K Components Ltd., referred to herein as B&K, warrants your B&K equipment against all defects in material and workmanship for a period of five years from the date of purchase. This warranty applies only to the original purchaser and only to equipment in normal residential use and service. Defective equipment must be returned to B&K, prepaid, accompanied by proof of purchase and sufficient payment to cover the cost of return shipping and handling, and will be repaired or replaced at the discretion of B&K whose decision as to the method of reparation will be final.

This warranty shall not apply to any equipment which is found to have been improperly installed, incorrectly fused, misused, abused, or subjected to harmful elements, used in any way not in accordance with instructions supplied with the unit, or to have been modified, repaired or altered in any way without the expressed, written consent of B&K. This warranty does not apply to the cabinet or appearance items such as the faceplate or control buttons, nor does it cover any expenses incurred in shipping the unit to and from the manufacturer's service department.

This warranty on B&K Components, Ltd. products is NOT VALID if the products have been purchased from an unauthorized dealer or an E-tailer or if the original factory serial number has been removed, defaced or replaced in any way. B&K Components, Ltd. sells its products through authorized dealers in order to insure that consumers obtain proper dealer service and support. Buying from an authorized B&K Components, Ltd. dealer insures that you have a FACTORY WARRANTY on your B&K Components, Ltd. product. If you have any questions concerning your Factory Warranty call B&K Components, Ltd. at 716-656-0026.

Upgradability: B&K is one the first manufacturers in the audio/video industry to consistently offer software and hardware upgrades to its processing of audio signals. Through upgrades B&K delivers exceptional value to its customers. But what is "Upgradability"? Upgradability is not a guarantee; we define it as a philosophy of designing and manufacturing products so that as audio technology evolves, B&K can provide enhancements and improvements to its products that are economically viable.

THE EXPRESS FACTORY WARRANTY HEREIN CONTAINED IS IN LIEU OF ANY AND ALL OTHER WARRANTIES, EXPRESSED OR IMPLIED, INCLUDING ANY WARRANTY OF MERCHANTABILITY, UPGRADABILITY OR OF FITNESS FOR ANY PARTICULAR PURPOSE. B&K COMPONENTS, LTD. SHALL NOT UNDER ANY CIRCUMSTANCES BE LIABLE FOR DAMAGES, INCLUDING SPECIAL, INCIDENTAL, EXEMPLARY, PUNITIVE OR CONSEQUENTIAL DAMAGES ARISING OUT OF OR IN CONNECTION WITH THE PURCHASE, USE OR PERFORMANCE OF ANY B&K PRODUCT.

This warranty gives you specific legal rights. You may also have other rights which vary from State to State. Some States do not allow the exclusion or limitation of incidental or consequential damages and the foregoing exclusions may not apply to you.

No agent, representative, dealer or employee of B&K has the authority to increase or alter the obligations or terms of this warranty.

Returning Equipment

No equipment may be returned to B&K Components Ltd. without a RETURN AUTHORIZATION (RA). Should you find it necessary to return equipment to B&K, for any reason, a RETURN AUTHORIZATION (RA) number must be issued by B&K in respect of the equipment being returned. You may request an RA number by calling B&K at the numbers below. We will need the following information to issue your RA number. Please have it ready before you call.

1. Your name, address, and phone number.
2. The model and serial number of the equipment being returned.
3. A description of the problem being experienced.
4. Your sales receipt.

Your call will be referred to a Technical Service Representative who will work with you to resolve the problem. If it is determined that the unit must be returned for repair, an RA number will be issued.

TABLE OF CONTENTS

ACCESSORIES AND LIMITED WARRANTY	ii
TABLE OF CONTENTS	1
SAFETY PRECAUTIONS	2
PURPOSE AND FUNCTION	3
BACK PANEL	4
INPUTS	5
INPUT/OUTPUT CONNECTIONS	6
SYSTEM INSTALLATION	7
CONTROL TRIGGERS	8
TROUBLESHOOTING	9
SPECIFICATIONS	Back Cover

Product Information

Date of Purchase: _____

Amp Model #: _____

Amp Serial #: _____

Purchased From: _____

Address: _____

Phone #: _____



Installation Considerations



WARNING: to prevent fire or shock hazard, do not expose this unit to rain or moisture. Care should be taken to prevent objects or liquid from entering the enclosure. Never handle the power cord with wet hands.

- The lightning flash with arrowhead within an equilateral triangle is intended to alert the user of the presence of uninsulated "dangerous voltage" within the product's enclosure that may constitute a risk of electric shock to you.
- The exclamation point within an equilateral triangle is intended to alert the user of the presence of important operating and maintenance (servicing) instructions in the literature accompanying the unit.
- Caution: To prevent the risk of electric shock, do not remove cover. No user-serviceable parts inside. Refer servicing to qualified service personnel.
- Unplug the amplifier from the AC outlet when plugging in or unplugging cables, when left unused for an extended period of time, moving the amplifier, or when you suspect lightning in your area.
- Prevent damage to the power cord. Do not bend, pull, place objects on, alter, etc. Replace the power cord if it becomes damaged. Always grasp the plug on the power cord when plugging in or unplugging the amplifier from the AC outlet.
- Your system may produce sound levels capable of causing permanent hearing loss. Do not operate for extended periods of time at high volume levels.
- Make sure the amplifier is placed on a level surface.
- The amplifier is equipped with raised feet to provide ventilation, reduce acoustic feedback, and provide protection against scratching the surface the unit is resting on. We advise against removing or altering feet.
- Do not stack anything on top of the amplifier (processor, source, etc.) **Leave a minimum of 3"** clearance from the top of the amplifier to the next shelf (or component) to insure proper ventilation.
- The amplifier should be located away from other sources that may be sensitive to heat.
- Do not perform any internal modifications to the amplifier.
- Always connect the amplifier's power cord to an unswitched, dedicated AC outlet for normal operation.
- If young children are present, adult supervision should be provided until the children are capable of following all rules for safe operation.
- Mistaking CONTROL OUTPUT or CONTROL INPUT connectors for audio/video inputs or outputs may damage your amplifier or other components.
- Damage can occur to your speakers if the power rating of each individual driver is exceeded by the amplifier. Ensure that all the drivers in your system are capable of handling not only the average power being delivered by the amplifiers, but also the peak power that is likely to be generated during strong passages.
- Reference 125.2 S2 amplifier can have speakers connected in parallel to each amp channel. System impedance **SHOULD NOT** fall below the nominal impedance of the amplifier, i.e two 8Ω speakers in parallel = 4Ω (system impedance). Minimum stability refers to the periodic audio passages that demand large amounts of current at which time the output impedance drops.

The amplifier should be serviced by qualified personnel when:

- A. The amplifier is not functioning properly.
- B. Objects have entered the chassis.
- C. The amplifier was exposed to rain or other type of moisture.
- D. The amplifier was dropped, or the chassis is damaged.

PURPOSE AND FUNCTION

The Reference 125.2 S2 (Two channel) is a high power amplifier that is designed for use in all types of audio or audio/video systems.

DESIGN AND CONSTRUCTION

The Reference 125.2 S2 amplifier utilizes high quality electronic circuitry to achieve an environment wherein a detailed, transparent, and highly musical sound can be realized. The high quality parts complement includes: state-of-the-art solid state devices, 1% metal film resistors, computer grade electrolytic power supply capacitors, and a high capacity toroidal transformer. All B&K products are designed and hand assembled in Buffalo, NY U.S.A.

The Reference 125.2 S2 operates with a class A predriver and AB MOSFET power output stages. These high power amplifiers are capable of delivering full range while reproducing the most demanding music passages effortlessly into the most demanding audiophile speakers.

FEATURES

High Current - Ability to cleanly, accurately, and reliably reproduce demanding recordings or source materials into low impedance drivers and speaker systems.

Class A Predriver - Improves low level detail and clarity for smoother, more musical sound.

AB MOSFET Output - Provides efficient and linear power delivery, as well as protection from thermal overload.

Gold Plated Connectors - Improved sound with minimum signal loss and degradation.

Five Way Binding Posts - High quality binding posts accommodate up to 4 gauge wire.

Control Output - One 3.5mm (1/8") 10-12 VDC @ 200 mA output for controlling other amplifiers or controlling external systems that use a voltage trigger.

Control Input - One 3.5mm (1/8") jack that allows standby on/off with a 5-24 VDC control signal.

Toroidal Transformer - Efficient, high current, shielded transformer that supplies the amplifier with a clean and constant supply of power, even during highly demanding source material passages.

Discrete Circuitry - Dynamically provides a full, accurate, and three dimensional reproduction of source material.

1% Metal Film Resistors - High quality resistors used in all active circuitry to reduce noise and obtain better sound purity.

Computer Grade Capacitors - Large capacity computer grade electrolytic capacitors for extended low frequency control, increased power supply, and improved dynamics.

Balanced Inputs - Balanced inputs deliver the quietest and most accurate signal path between the preamplifier and amplifier.

Full Power Operation - Capability to operate at full power with a square wave input.

Differential Input Stage - A current source load assures DC stability and wide bandwidth linearity.

5 Year Factory Warranty - All B&K products sold through an authorized dealers are covered by a 5 year parts and labor factory Warranty.

AVAILABLE FACEPLATES

17" Black (Standard)

17" Silver (Optional)

19" Black Rack Mount (Optional)

19" Silver Rack Mount (Optional)

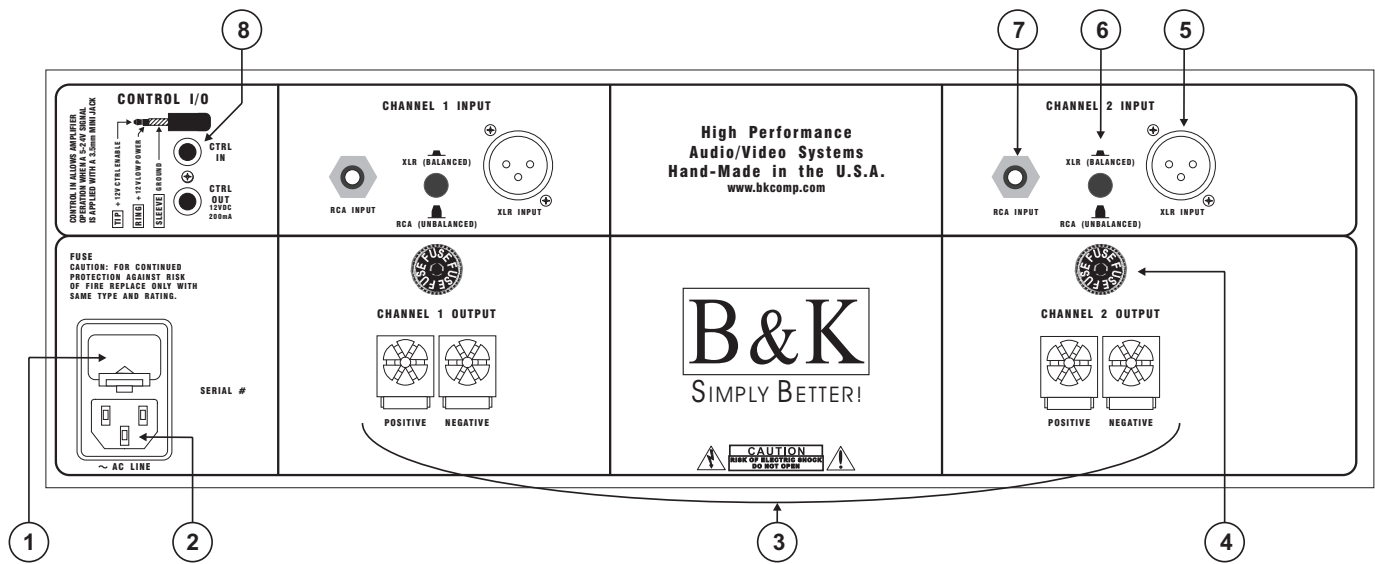

1. AC Fuse Holder - Holds the AC line fuse. This fuse is an 8 amp / 250 volt slow blow fuse. Replace only with the same type and value fuse.

2. AC Input Receptacle - For attaching the supplied AC power cord to the amplifier.

3. Speaker Outputs - For connecting the speakers to the amplifier. Explained further on page 6.

4. Speaker Fuses - For protection against amplifier damage in the case of shorted speaker wires. Replace fuse with the same type and value 4 amp slow blow.

5. Balanced (XLR) Input - For connecting signal patch cables (interconnects) from the preamplifier to the amplifier. Explained further on page 5 and 6.

6. Balanced/Unbalanced Input Select - This switch is used to configure a SINGLE AMPLIFIER CHANNEL for use with either balanced (XLR) or unbalanced (RCA) inputs. This switch controls the amplifier channel and allows signal patch cables (interconnects) to be sourced from either balanced or unbalanced, preamplifier/processor or outputs. Explained further on page 5 and 6.

7. Unbalanced (RCA) Input - For connecting signal patch cables (interconnects) from the preamplifier to the amplifier. Explained further on page 5 and 6.

8. Amplifier Control Input/Output - Provides remote switching of the amplifier's standby on/off feature. Explained further on page 8.

INPUTS

The Reference 125.2 S2 allows signal patch cables (interconnects) to be sourced from either balanced or unbalanced volume level preamplifier/processor outputs. A switch is used to configure a SINGLE AMPLIFIER CHANNEL for use with either a balanced (XLR) or unbalanced (RCA) output.

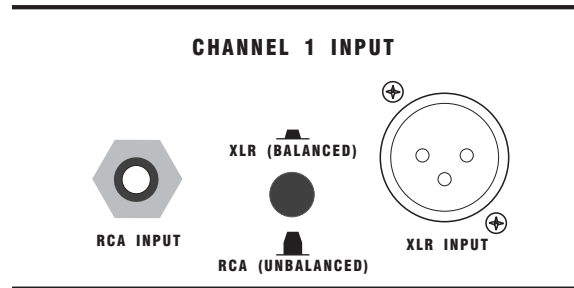

XLR BALANCED

There are two balanced input connectors on the Reference 125.2 S2. These connectors accept balanced volume level output from the preamplifier's balanced output connectors.

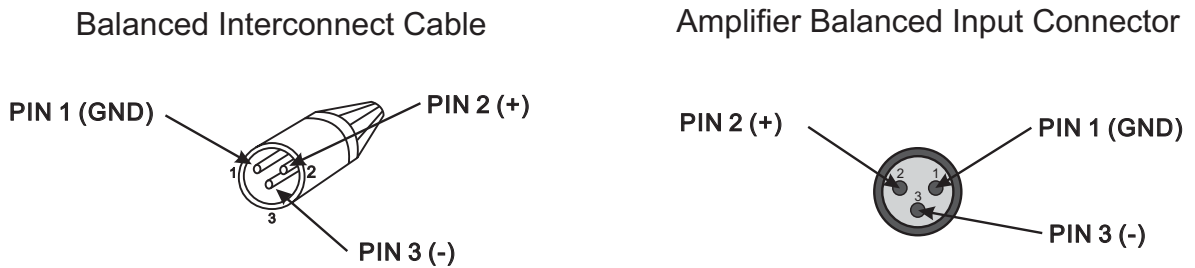

RCA UNBALANCED

There are two unbalanced (RCA) input connectors on the Reference 125.2 S2. These connectors accept an unbalanced (RCA) output from the preamplifier's (RCA) volume level outputs.

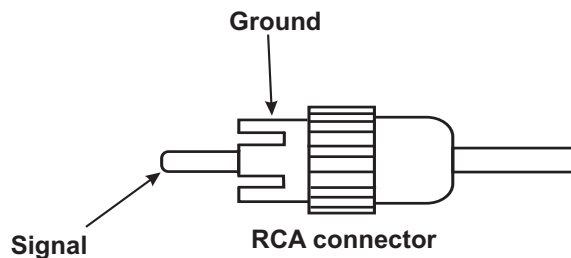

Use either RCA unbalanced or XLR balanced to connect the preamplifier to amplifier.

RCA Unbalanced Connections

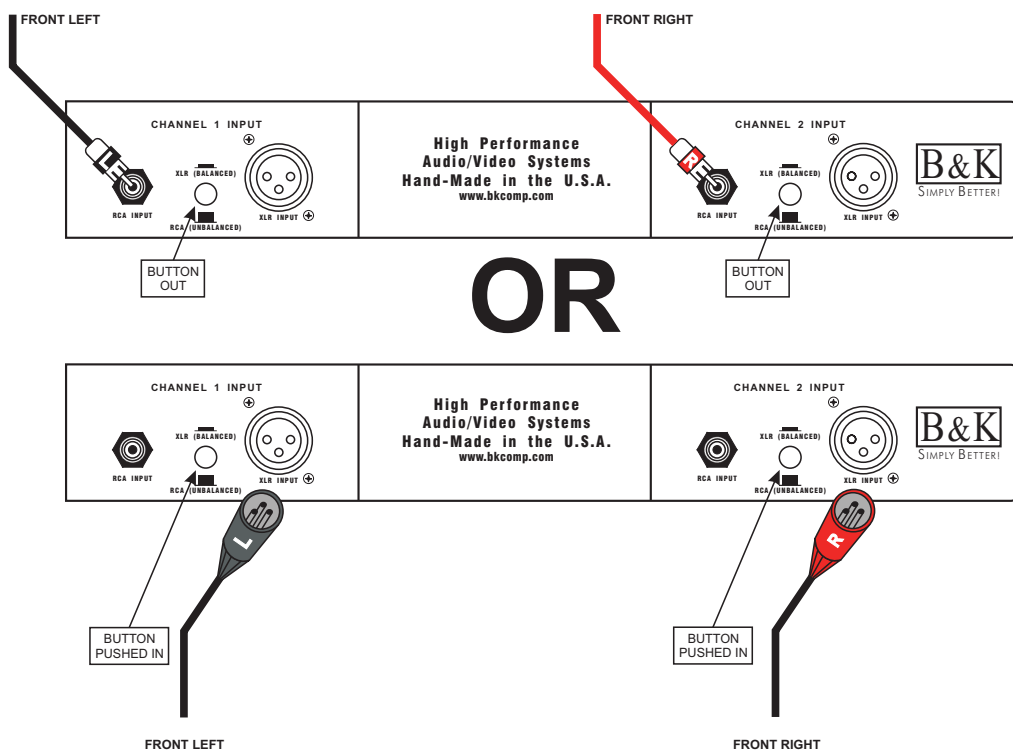

XLR Balanced Connections

SPEAKER OUTPUTS

Binding posts are provided for speaker connections. There is one pair provided for each amplifier channel output. They are designed to accept a banana-type plug, spade-lug connector (shown right), terminal posts, or bare wire. They are color coded for easy identification. The positive (+) RED post should always be connected to the speakers (+) RED jack. The negative (-) BLACK post should always be connected to the speakers (-) BLACK jack.

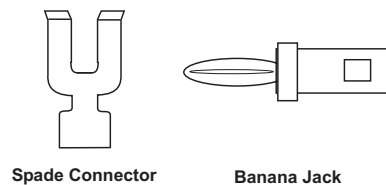

Shown right is the amplifier to speaker connections (4 gauge (AWG) wire maximum).

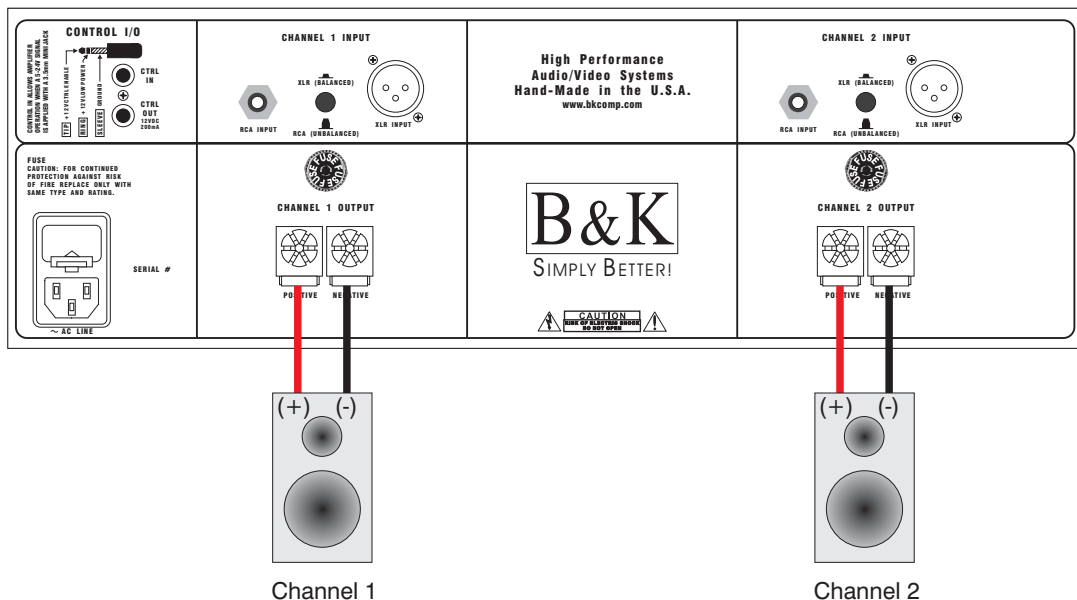

There will most likely be a number of cables involved in the installation of your home entertainment system. Preplanning is essential in order to maximize system efficiency. We recommend the following as a means of helping you reach that goal.

- When possible, use a dedicated AC power line for the amplifier, one that is not shared by any other household component. **THIS IS VERY IMPORTANT!!**
- Make a diagram of your proposed system by laying out the relative location of each component in the system. Then lay out the proposed cable runs between them. Number each cable and record its length.
- Cable runs are critical in that they must be kept away from the sources of power radiation (amplifiers, power cords, heaters, appliances, etc.). For safety reasons, they should also be kept out of traffic areas.
- The process of optimizing the system will include the type of cable, the length of the run, and the obstructions it must deal with along its run. Your dealer can advise you on the products available and their relative merits. If building custom length audio cable is not your strength, your dealer should be able to help you with that as well.

Tip: Take a piece of string (longer than the longest cable run) and mark it at each foot of length. Then do a mock cable run using the string, dressing it neatly along the way. Count the divisions to the next full foot, and add one foot to all for some movement of the components. This will provide you with ideal cable length.

MAKING THE CONNECTION

Refer to back panel on page 4

- As a precaution, insure that the power switch on the amplifier's front panel is in the 'off' position and AC power is disconnected before making any connections.
- Connect the wires from your speakers to the appropriate output channels on the amplifier. It is essential that correct polarity is observed in all connections.
- Connect the audio cables from the preamplifier's audio outputs to the amplifier input channels using either balanced (XLR) or unbalanced (RCA) interconnects.

Example: Connect Front Left output of the preamplifier to channel 1 of the amplifier, connect the Front Left speaker wires to channel 1's outputs. Always observe polarity when connecting speakers, i.e. amplifier (+) RED to the speaker (+) RED and amplifier (-) BLACK to speaker (-) BLACK.

- Double-check all connections.
- It is recommended that a dedicated AC power outlet is used for the amplifier, one that is not shared by any other audio or household component.
- Locate the AC power cord provided with the amplifier and plug it into the power input receptacle in the rear panel. Make sure front panel power switch is off (out). Do not connect to the AC power until speaker connections are complete!
- Connect a playback unit (CD, DVD, SAT, Tuner, etc.) to the preamplifier. Turn on the preamplifier, turn the volume on the preamplifier to a minimum level, and then turn on the amplifier using the power switch on the front panel (in this order). Set the source on the preamplifier to the playback unit connected. Turn the volume up slowly and listen for music from all channels.

If a problem is encountered that cannot be traced to the hardware connections or to the material being played, consult the "TROUBLESHOOTING" section on page 9.

Note: *If the control triggers are not being used, the amplifier should always be turned off first, then the preamplifier. Before turning anything on, insure the preamplifier is at a low volume level.*

A control (trigger) system is provided on the Reference 125.2 S2 amplifiers to allow remote switching of the amplifier's standby on/off feature. The control input is designed to operate with a source (trigger) of 5-24 volts DC. All B&K A/V processors and preamplifiers utilize control output triggers to easily integrate an amplifier into an audio system.

In addition, your amplifier has a control output circuit to allow control of an external device such as another power amplifier, projection screen, power strip, etc. The control output has the capability to source 10-12VDC @ 200 mA (on) or 0 VDC (off).

If more than one amplifier is being controlled, the control output may be extended to include each successive unit by simply connecting a 3.5mm (1/8") mini-jack cable from the CTRL OUT connector of the first amplifier to the CTRL IN connector of next amp (commonly referred to as 'daisy chaining'). An example of how to connect two amplifiers is illustrated in the diagram below.

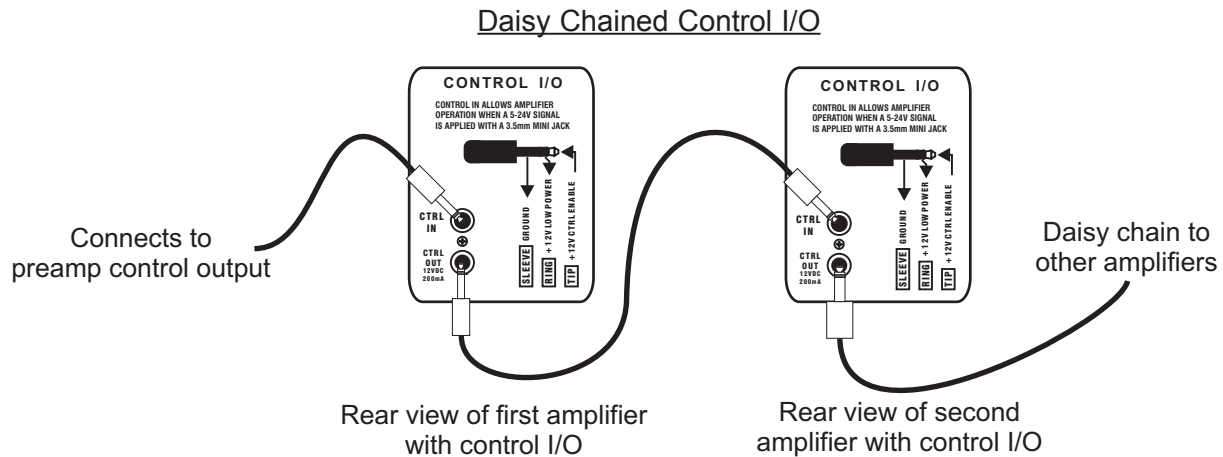

DO NOT POWER MOTORS WITH THE CONTROL OUT CIRCUIT!!!

If the control function is desired, each unit in the system must remain connected. The control is enabled when the 3.5mm jack is inserted into the CTRL IN. For more information on the amplifier's output status under various control conditions, refer to the table below.

*Note: The control input voltage is intended for standby on/off control only. For best amplifier operation, each amplifier should have its own source of AC power.

Operational Outline

Hardware (3.5mm)	@ CTRL IN	Output Status	@ CTRL OUT
Not Connected	No Voltage	Sound	+12V
Connected	No Voltage	No Sound	0V
Connected	Voltage	Sound	+12V

PROBLEM	POSSIBLE CAUSE	POSSIBLE SOLUTION
No sound (power 'on' LED not illuminated).	<ol style="list-style-type: none"> 1. Power cord not plugged in. 2. Power off at AC source. 3. AC power inlet fuse blown or faulty. 4. Control voltage not activated. 5. Power switch in off position (out). 	<ol style="list-style-type: none"> 1. Reconnect power cord. 2. Check AC switch or fuse. 3. Check for shorts or overloading. 4. Supply Control IN with a 5-24 Volt DC supply (Page 8). 5. Push in power switch.
No sound on some or all selected channels (power 'on' LED illuminated).	<ol style="list-style-type: none"> 1. Speaker leads loose or faulty. 2. Preamp to amp cables loose or faulty. 3. Source to line stage cables loose or faulty. 4. Line stage or source not correctly selected. 5. Speaker fuse blown. 6. Balanced button "in" when using RCA's. 	<ol style="list-style-type: none"> 1. Tighten, repair or replace cable. 2. Tighten, repair or replace cable. 3. Tighten, repair or replace cable. 4. Check all source settings. 5. Check all speaker fuses and replace if blown. Replace fuse with same type and value. 6. Press balanced button to switch balanced inputs off (out position).
Sound lacks direction weak bass.	<ol style="list-style-type: none"> 1. Speakers connected out of phase. 	<ol style="list-style-type: none"> 1. Check all connections making sure that cables are connected (+) to (+) and (-) to (-).
Loud hum or buzz on one or more channels.	<ol style="list-style-type: none"> 1. Poor ground connection in inter-connect cables. 	<ol style="list-style-type: none"> 1. Check all connectors and repair as necessary.
Channel sounds distorted and low output.	<ol style="list-style-type: none"> 1. Blown rail fuse. 	<ol style="list-style-type: none"> 1. WARNING: Blown rail fuses can be an indication of a larger problem. Replace ONLY with same type and value. If fuses continue to blow, consult a service professional. Rail fuses require internal service.

***Note: If unit continues to blow power fuses, DO NOT USE A HIGHER RATED FUSE, please contact customer service to have the unit serviced. When servicing fuses **always disconnect AC power before replacing.**

CARE AND CLEANING

Under normal use, the amplifier will not require any special care. Over time you may wish to clean the exterior of the unit by wiping it with a cloth to remove any dirt or dust that accumulates on it. Unplug the amplifier and be sure that it has completely powered down before cleaning. Do not let any liquid enter the amplifier through the vents in the top cover. **LIQUIDS CONDUCT ELECTRICITY!!!** You may clean the connectors on the back panel with isopropyl alcohol annually.

SPECIFICATIONS

REFERENCE 125.2 S2

Power Rating: 8Ω	125 watts						
Power Rating: 4Ω	185 watts						
Number of Channels	2						
Current (peak to peak)	30 Amps						
Dynamic Headroom	1.2 dB						
Total Harmonic Distortion (THD)	0.09 %						
Signal to Noise (S/N)	95 dB						
Input Impedance	33.2 kΩ						
Damping Factor (50 Hz)	180						
Frequency Response	5 Hz - 45 kHz						
Slew Rate	14 V / μsec						
Input Sensitivity RCA Unbalanced	1.0 Volt						
Input Sensitivity XLR Balanced	2.8 Volts Pin 1 = Gnd Pin 2 = In + Pin 3 = In -						
Gain	28.3AV* or 28dB						
AC Line Voltage	120 / 220 / 240 VAC (optional / switchable)						
Level Controls	No						
Binding Post Maximum Wire Gauge	4 AWG						
Balanced Inputs	Yes						
Control Input	5 - 24 VDC						
Control Output	10 - 12VDC 200mA						
Dimensions in Inches (Cutout Dimensions)	<table style="width: 100%; border: none;"> <tr> <td style="width: 30%; border: none;">Width</td> <td style="border: none;">17.00 (17.12)</td> </tr> <tr> <td style="border: none;">Height</td> <td style="border: none;">5.78 (5.90)</td> </tr> <tr> <td style="border: none;">Depth</td> <td style="border: none;">15.63 (16.75)</td> </tr> </table>	Width	17.00 (17.12)	Height	5.78 (5.90)	Depth	15.63 (16.75)
Width	17.00 (17.12)						
Height	5.78 (5.90)						
Depth	15.63 (16.75)						
Shipping Weight	31 lbs						
Power Consumption	680 watts max 7.5 Amps max current draw 60 watts @ no input						
Replacement Fuses	AC Line - 8 Amp / 250 Volt Slow Blow Rails - 4 Amp / 250 Volt Time-Lag Speakers - 4 Amp / 250 Volt Slow Blow						

*AV - Amplified Voltage